

SPARK





Basketball Hoop Manual

READ MANUAL FIRST

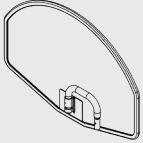

Version 1.1

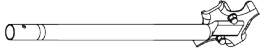
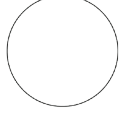
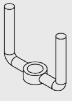
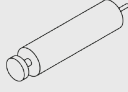
Parts Check List

Part No	Parts	Quantity	Part No	Parts	Quantity
1		1	5		2
2		1	6		1
3		1	7		1
4		2			

Swing Set Parts Location Guide (Please refer to the table above)

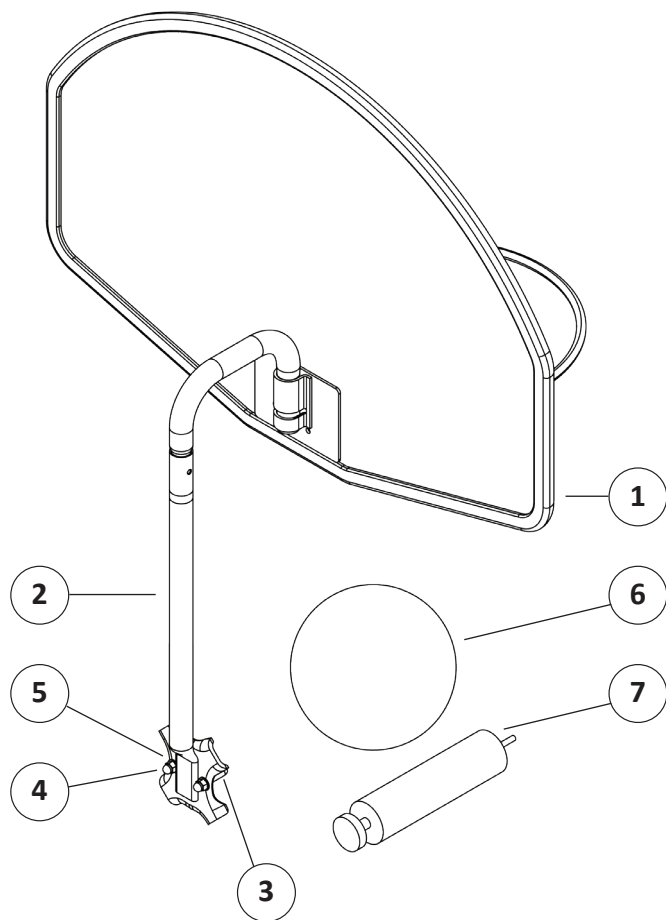

Preparation



1



2

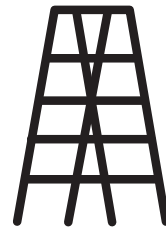

3

- 1. Gloves:** It is recommend that people who are willing to install the basketball hoop should wear gloves to prevent injuries.
- 2. Tools:** Screwdriver is recommended to install basketball hoop set
- 3. Ladder:** Ladder is recommend to install the basketball hoop part.

Assembly Guide

Step 1

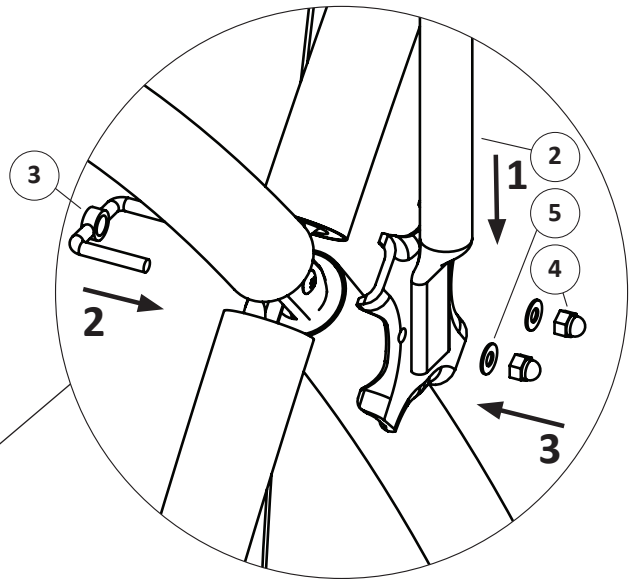
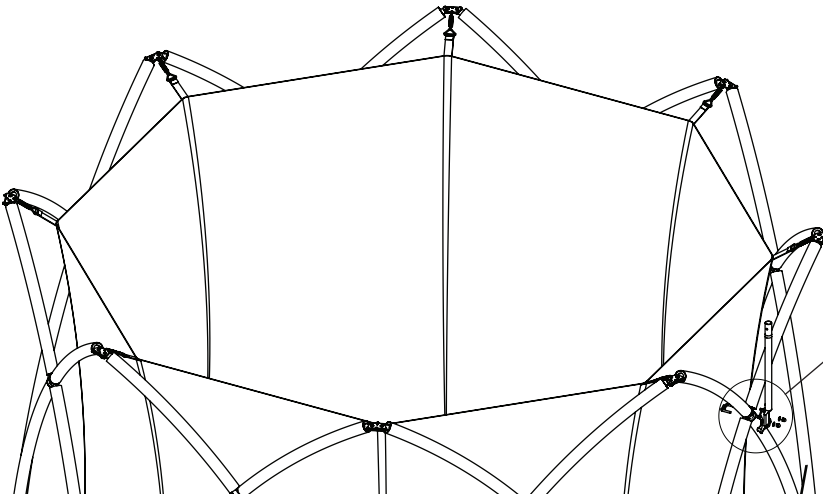

Step 2

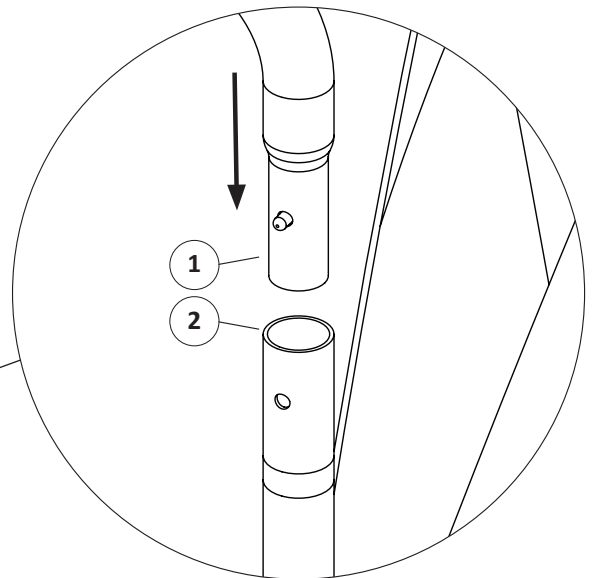
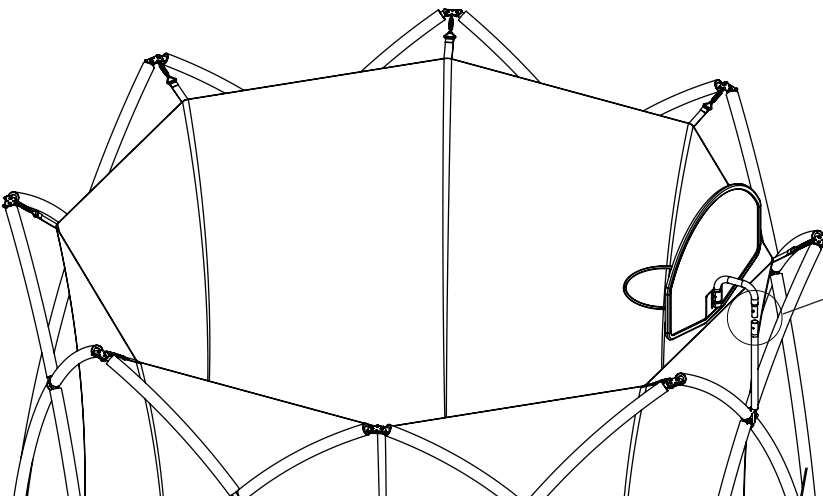

Congratulations you have successfully installed Basketball Hoop Set!

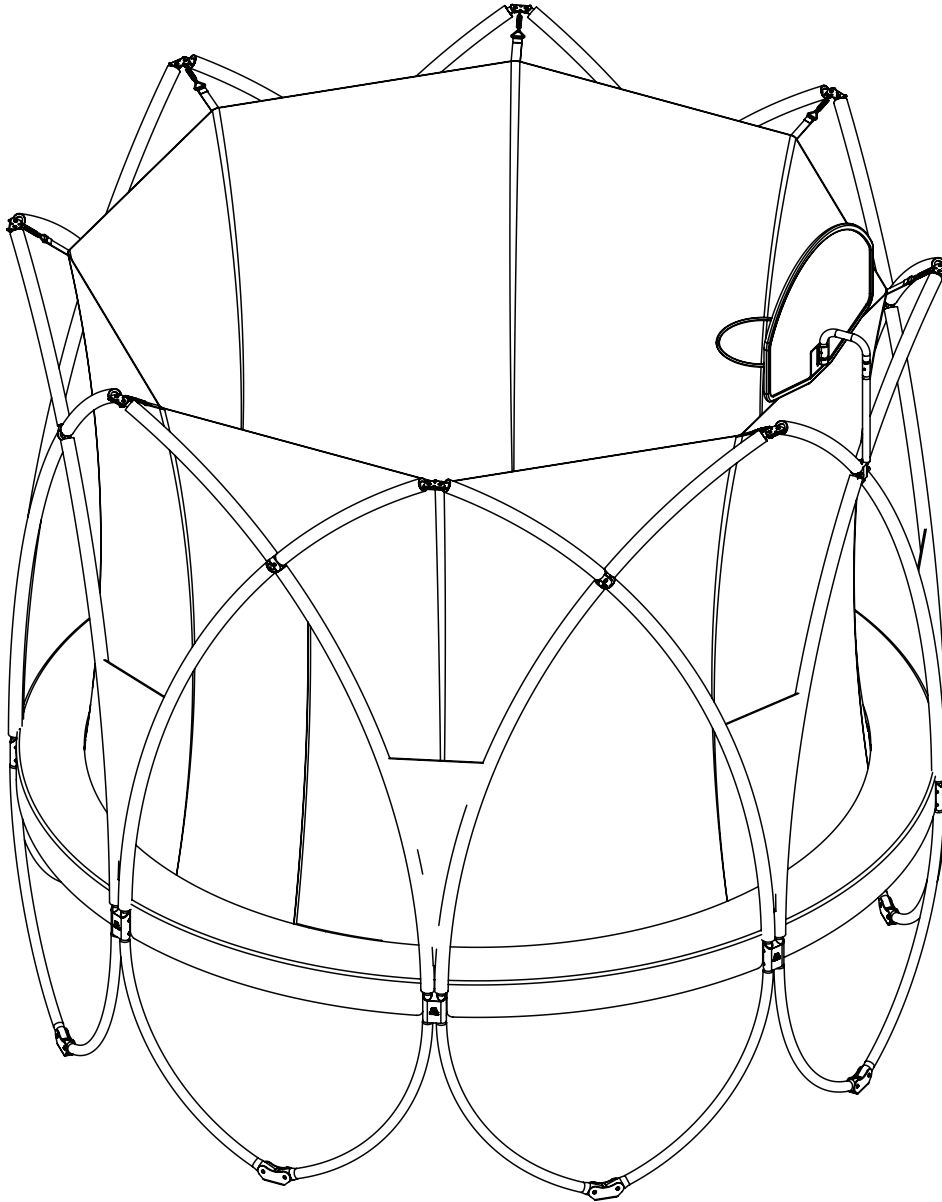

WARNING

- This basketball hoop set is for family domestic use only.
- Children of all ages must be supervised by an adult at all times when playing this basketball hoop set.
- Adult assembly of this basketball hoop set is required.

Read and understand enclosed safety information before assembly and use of the basketball hoop set.

MAINTENANCE INSTRUCTION

To maximise the life of your basketball hoop set. It is important to check and inspect before each use of the basketball hoop set, and carry out necessary maintenance immediately.